

E05-AC40069



TECHNICAL DATA

ITEM DESCRIPTION	TOILET BRUSH HOLDER
ITEM CODE	E05-AC40069
DIMENSIONS	W X H X D (MM) 90 X 113 X 145
FINISHES	P00 - CHROME
	P01 - MATT BLACK
	P06 - LIGHT GUNMETAL
	P18 - POLISHED CHAMPAGNE
	P19 - BRUSHED CHAMPAGNE

TECHNICAL DRAWINGS

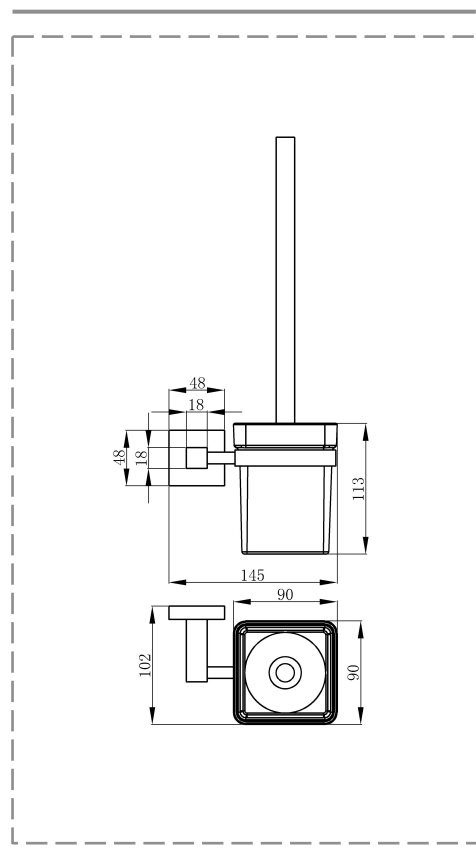

TECHNOLOGY - CERTIFICATION

PRODUCT TYPE	:	WALL MOUNTED
MATERIAL	:	BRASS
STANDARD	:	CE STANDARD