

E05-AC40023



TECHNICAL DATA

ITEM DESCRIPTION	SOAP DISH HOLDER
ITEM CODE	E05-AC40023
DIMENSIONS	W X H X D (MM) 110 X 50 X 120
FINISHES	P00 - CHROME P01 - MATT BLACK P06 - LIGHT GUNMETAL P18 - POLISHED CHAMPAGNE P19 - BRUSHED CHAMPAGNE

TECHNICAL DRAWINGS

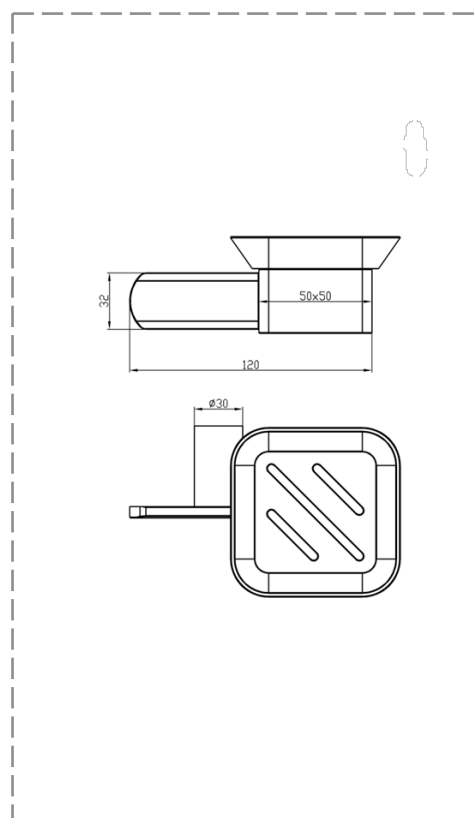

TECHNOLOGY - CERTIFICATION

PRODUCT TYPE	:	WALL MOUNTED
MATERIAL	:	BRASS
STANDARD	:	CE STANDARD